

Infinity®

Kappa 5.1

S P E A K E R S

OWNER'S MANUAL

Kappa 5.1

INTRODUCTION

You have invested in one of the finest speakers available. Your Infinity Kappa 5.1 speakers employ new technology in driver, crossover and cabinet construction which places it at the fore-front of current speaker design. As with any high quality

product, special care must be taken to install and operate your new speakers. It is for this reason we suggest you read this manual carefully from cover to cover prior to installation.

UNPACKING

Upon opening the carton, inspect the speakers carefully for any sign of transit damage. If there is damage, immediately call your dealer or the trucking firm that made the delivery. Do not delay

in reporting the damage because the longer you wait, the more difficult it will become to file a claim.

It is suggested that you fold the carton flat and store it for future use.

ASSOCIATED COMPONENTS

Your Infinity Kappa 5.1 speakers make up a highly musical system. Like all loudspeakers, they will reproduce distortion as well as music. For this reason, the choice of associated audio components is critical and should be made with care. If you are replacing existing speakers with an Infinity Kappa 5.1 system, there should be an audible improvement in sonic quality, assuming your other components are at least on a par with Kappa in terms of low distortion, phase linearity, frequency response, and so on.

If no improvement is heard, or if the sound deteriorates, it is possible that one (or more) of your existing components is of a lower standard than your new Infinity speakers. When a speaker system is exceptionally revealing, musical colorations and other forms of distortion become more noticeable because these aberrations are no longer masked by the speaker.

Here are some suggestions which will prove useful in obtaining a well-balanced audio system:

- ◆ Employ an amplifier with as much power as possible. Since quality speakers work best when driven by a high current, the choice of an amplifier with a strong, adequate power supply and a heavy-duty and rugged output stage

generally results in cleaner, better defined bass response. And, while low distortion, excellent phase characteristics, and low noise are all extremely important performance parameters, sufficient power into a low impedance load on a continuous basis is equally important.

- ◆ Another consideration is that a lower power amplifier operating at its maximum power output can damage a speaker more quickly than a high power amplifier playing at loud sound levels. This occurs because many amplifiers “clip” their output very “hard” when over-driven, creating high frequency distortion which can cause the voice coil of a tweeter to heat and eventually fail. Always choose an amplifier with high power. Your authorized Infinity dealer can best answer your questions and make recommendations.
- ◆ The Kappa 5.1 speakers are extremely revealing and will quickly identify sonic anomalies within the listening system. Poor quality speaker cables and component interconnects can add harshness, detract from spaciousness and reduce airiness surrounding instruments and voice.

CONNECTION USING A STEREO AMPLIFIER

Always turn off the power of your entire system before making connections to your speakers.

Connect each speaker to your amplifier's output terminals using the heaviest gauge wire you can obtain. The choice of speaker connecting wire is extremely important, especially when using speakers as sonically revealing as the Infinity Kappa 5.1. If inferior wire is used, sonic quality will suffer and the degradation of sound will be readily audible. For best results, do not use wire that is thinner than 16 gauge. **NOTE: The lower the gauge number (16, 14, 12, etc.), the heavier the wire.**

Although gauge alone does not reveal the ultimate sonic quality of wire, it represents a good starting point especially if you are not using a name brand speaker connecting cable. Consult your dealer if you are not certain which type of wire will make your Infinity speaker sound best.

When using regular lamp cord, look for ridges or different colored insulation to differentiate polarity. If there is a ridge on the outer insulation, use the ridge for positive (+) and the wire without the ridge for negative (-). If the insulation wrapped around one wire is red, use it for positive. Use white (or whatever the other color may be) for negative. See Figure 1.

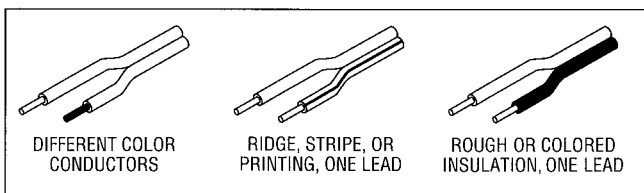

FIGURE 1 – Some examples of polarity coding on speaker cables

It is important to connect your speaker in phase (which means that all individual drivers are moving in and out in the same direction and at the same time) in order to obtain the best localization of instruments and voice as well as the deepest, most natural bass. If a speaker is out of phase, the drivers in one channel will move in while the other channel will move out. This condition invariably results in sonic problems and must be avoided.

Using one length of speaker connecting wire, connect the RIGHT speaker to your amplifier's (or receiver's) RIGHT channel output terminals. Be sure that strands of the wire do not touch the ground terminal (and be sure to observe polarity). Even a thin stray wire can cause distortion in the system which would be very difficult to trace. Speaker Positive should be connected to amplifier Positive and speaker Negative to amplifier Negative. Connect the LEFT speaker to your amplifier's LEFT channel output terminals in a similar manner. See Figure 2.

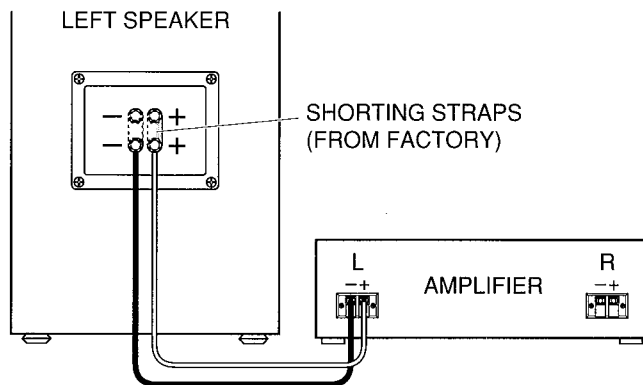

FIGURE 2 – Speaker connection

CONNECTION FOR BI-AMP OPERATION

Your Infinity Kappa 5.1 speakers permit you to employ two power amplifiers in a bi-amp configuration. One amplifier feeds the woofer (the signal passes through the speaker's crossover network to feed the woofer) and the other amplifier drives the remainder of the speaker system. This arrangement generally results in the purest and most open sound obtainable from the speaker.

To connect your speaker to two amplifiers, merely remove the two gold-plated straps (which connect the bass and higher frequency section of the crossover network together for use with a single power amplifier) and connect one amplifier to the bass terminal and the other amplifier to the tweeter/midrange terminals. Observe polarity as detailed in the previous section. See Figure 3.

DO NOT ATTEMPT TO EMPLOY TWO SEPARATE AMPLIFIERS WITHOUT FIRST REMOVING THE SHORTING STRAPS ON THE REAR OF THE SPEAKER.

DO NOT REMOVE THE SHORTING STRAPS WHEN USING ONLY A SINGLE POWER AMPLIFIER (except when bi-wiring. Refer to the next section.)

If your amplifiers are not equal in power, always use the amplifier with the higher power (or greater current capability) to drive the woofers. When using two different amplifiers, it is recommended that at least one of the amplifiers has a level control which will permit you to set the level of one of the amplifiers to balance the other, resulting in equal output feeding the woofers and midrange/tweeter sections.

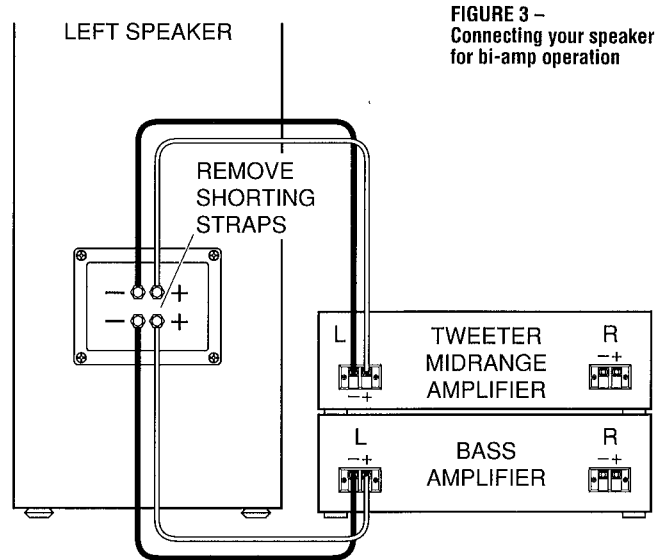

BI-WIRING

Many audiophiles recommend using two connecting wires instead of one because two wires share current through a greater conducting area.

If you wish to bi-wire your Kappa 5.1 speakers with a single power amplifier, remove the two shorting straps on the rear of the speaker which separates the woofer and midrange/tweeter sections of the crossover network. Two parallel speaker wires are connected to the amplifier's output (for each channel) and the other ends of the wires are connected to the woofer and midrange/tweeter sections of the speaker.

See figure 4.

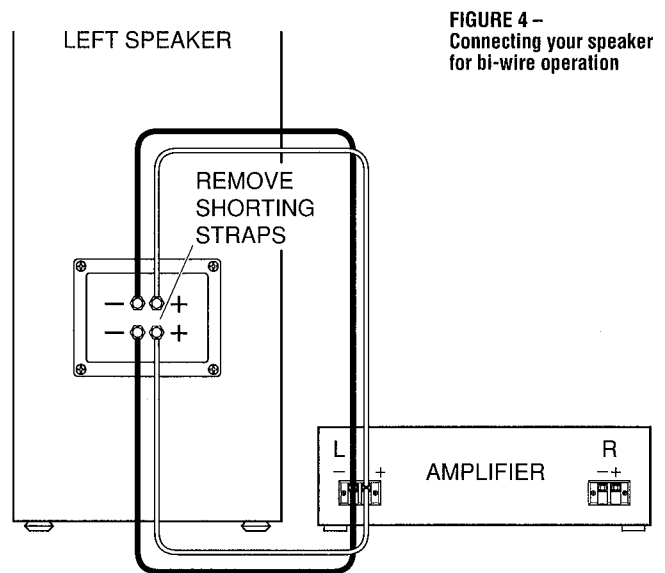

POSITIONING YOUR SPEAKERS

Locating your Kappa 5.1 speakers in the proper position within your listening room is of primary importance if you wish to obtain the best possible performance from your audio system. Depending on room size and acoustics, moving the speaker as little as an inch (2.5cm) forward, rearward, or sideways can result in noticeable sonic differences. We urge you, therefore, to experiment with placement until your speakers deliver their full musical potential.

As a useful starting point for best stereo imaging, place your speakers at least seven feet apart. Try to locate the speakers as far away as

possible from walls and corners of the room to reduce reflections which generally result in sonic anomalies. Our experience has shown that speaker placement too close to a wall or a corner can create hardness, smearing of the sound, lack of bass detail, and at times other forms of sonic distortion which reduce clarity and change the harmonic structure of music. Often as not, these sonic anomalies are blamed on the speakers but are really due to poor room placement. We cannot stress too strongly the importance of room placement and the role it plays in achieving excellent musical balance. *See Figure 5.*

When the speakers are moved inward (toward each other) this generally achieves better focus of instruments and vocalists; however, moving the speakers too close together can reduce the front-to-rear stage effect and you may need to experiment with the trade-off between focus and imaging.

If your listening room is larger than average and your listening position is relatively far from the speakers, wider placement of the speakers may be required (approximately 10 feet apart).

FIGURE 5 – Suggested starting placements for Kappa 5.1 speakers

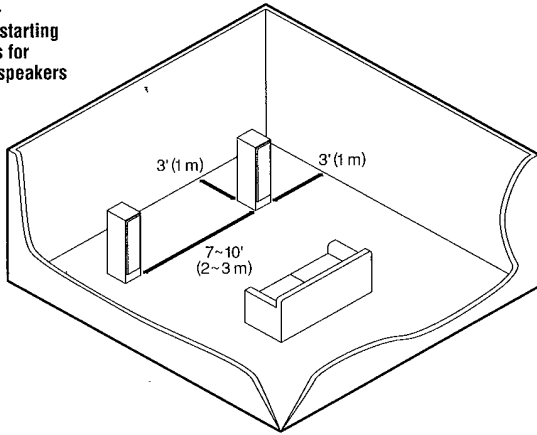

Try angling the speakers inward for better projection of midrange and high frequencies; however, do not angle the speakers too sharply because this may reduce stereo imaging as well as front-to-rear depth. The exact angle of toe-in must be determined by careful experimentation. There is no formula to follow because rooms differ in acoustics and the listener's position may vary considerably. See Figure 6.

The toe-in angle for each speaker should be exactly the same for best sonic results. This can be done effectively by eye or by using a tape measure or straight edge to measure the amount of toe-in from a forward firing position.

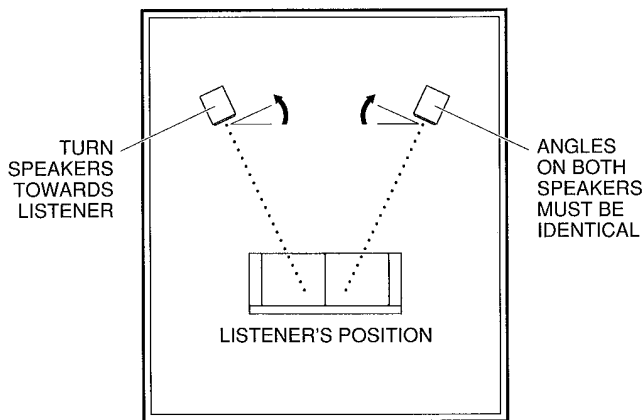

FIGURE 6 – Angling Kappa 5.1 speakers.

Toe-in, tilting and moving the speakers closer and further from walls and corners are all part of the speaker tuning procedure. Don't be afraid to experiment as this will result in the best sound. If a specific location yields satisfying results and you wish to continue to experiment with speaker placement, mark the ideal location so you can always return to it.

When installing your speakers, be very careful to keep them on the same plane (exactly the same distance from the front wall). It is advisable to use a tape measure or a string to measure the exact distance the speakers are located from the front wall. Also keep the fronts of the speakers aligned so they face in exactly the same direction. See Figure 7.

Room corners are difficult to cope with and you should try to keep the location of the speakers as far away from corners as possible. Corners add low frequency reinforcement and can create severe problems in bass frequencies, often accentuating bass response, making it inarticulate.

If bass response is inadequate, you may wish to move the speakers closer into the corners (or rear wall) for reinforcement; however, as a rule of thumb, always try to locate the speakers as far away from corners and walls as possible.

It is often difficult to balance bass response because it is within this particular frequency spectrum where the listening room becomes a substantial influence. In fact, the listening room, depending on how many reflective and absorptive areas there are, can influence the entire frequency range of music. It is for this reason that constant experimentation is required before a final decision is made as to where the speakers should be permanently placed. When moving the speakers around, listen for sound that is cohesive and evenly balanced across the audio spectrum. Use various types of program material when determining sonic balance.

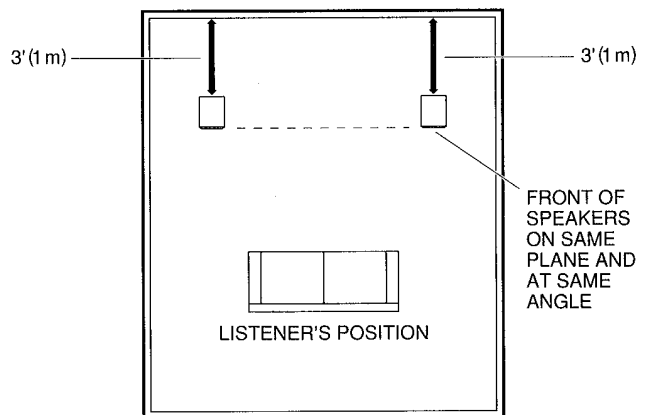

FIGURE 7 – Sound is most direct when midrange and tweeter reach the listener at ear level. Tilt speakers forward or rearward to direct sound at ear level.

KAPPA 5.1 EMIT-R PROTECTION CIRCUIT

Kappa 5.1 speakers include electronic protection in the crossover network to protect the EMIT-R Tweeter from excessive power and high frequency distortion which can be created when an amplifier is forced into clipping. If the tweeter turns off while playing music, turn off your entire audio system to allow the tweeter's protection electronics to cool. The electronic protection circuit will reset itself automatically once it reaches normal operating temperature. When the system is switched

back on, reduce overall volume by a small amount.

If the tweeter protection circuit continuously turns off, your amplifier may not have adequate power to drive your speakers and the amplifier is probably being driven into severe clipping. This form of overload generates high frequency distortion which can be damaging if the energy is allowed to reach the tweeter.

Consult your dealer or contact Infinity if you are experiencing this type of difficulty.

ROOM ACOUSTICS, SPEAKER POSITIONING, AND TONAL BALANCE

If you desire a more detailed description of room acoustics and speaker placement, the following information may prove helpful:

- ◆ Large areas of glass, mirrors, and wood paneling will reflect sound waves and often result in brittleness and excessive brightness. You can break the soundwaves created by hard surfaces with softer surfaces. Draperies or wall hangings will do a good job in absorbing standing waves created by hard surfaces. Placing a soft, absorptive piece of furniture near the hard surface often helps reduce unwanted spurious sound waves. Be careful not to absorb too much sound as this will interfere with sonic balance, causing overall sound to be dull and lifeless.
- ◆ A good listening room has just the right amount of reflection and absorption. To test the sonic balance of your room, stand in the location where the speakers will be installed and clap your hands two or three times. If the room is reverberant, you will hear a sharpness or echo.

If the room is dull, the sound of the clap will decay rapidly and there will be very little or no echo. In fact, it will seem that the higher frequencies generated by the clap will be missing.

- ◆ Furniture, pictures, bookcases, tables, and lamps will help reduce reflections because they are located at random points in the room and this tends to cancel standing waves. Carpeting or throw rugs also help reduce floor reflections, although heavy carpeting can absorb a great deal of the higher frequencies which will make the room seem less "bass heavy."
- ◆ It is customary to place the speakers facing into the long dimension of the listening room; however, this doesn't always result in the best sound. At times, placing the speakers facing into the short dimension of the room will yield better results due to the acoustic properties of the room and the listener's position. Experiment with room placement. You may be pleasantly surprised by the results.

SETTING THE AUDIO SYSTEM CONTROLS

Never operate your audio system with the equalizer, tone, and loudness controls set to maximum boost. This will place undue strain on the amplifier and could also result in damage to the speakers.

The position of the volume control setting is of little consequence in judging the amount of power a system generates. Loudness is a function of audio gain, which in itself is unimportant to the user. The only important consideration is the loudness level at which the system can be played, regardless of where the volume control is set.

Always turn down the volume of your system completely when changing a record or switching inputs from phono or CD to FM, etc. Excessively loud transients, which can result from a dropped stylus on a record or from improperly designed switches, can result in severe damage to your speakers.

Furthermore, when changing wires, pulling plugs, etc., *always* turn off all the equipment to prevent transients from entering the speaker. Use caution, and your speaker will repay you with many years of trouble-free service.

ACOUSTIC FEEDBACK

If, after connecting your system you find the bass response to be boomy (or lacking in tightness and solidity) or if the bass driver cones produce excessive movement, the cause can usually be attributed to acoustic feedback – vibrations from the speakers reaching a turntable and tone arm, creating a resonance. In turn, this vibration is fed back to the electronics and speaker. Since Kappa 5.1 speakers extend to very low frequencies, isolating the turntable from vibrations becomes an important procedure.

The turntable should be placed on a heavy, solid

support located as far from the speaker as possible. At times, using a shock mounted base helps reduce vibration pickup. If after trying various methods to reduce acoustic feedback the phenomenon still exists, contact your dealer for assistance.

NOTE: CD players are also susceptible to acoustic feedback and should be mounted on solid supports to isolate them acoustically. Another method to isolate the CD player is to mount it on four rubber or plastic legs which have a predetermined amount of elasticity.

CARE OF YOUR SPEAKER

Use a soft cloth and a fine furniture oil to clean the wood finish. If you use a spray cleaner/polish, be careful not to spray the polish on the grille

cloth. The grille may be vacuumed occasionally, but always set the vacuum cleaner on low suction to avoid tearing the cloth.

IN THE EVENT OF TROUBLE

Note that you can use your amplifier's two channels of information for simple trouble-shooting. If the sound quality is distorted, listen to each speaker separately to check if the fault is present in both. If it is, then the trouble is likely to be elsewhere in your system. If the fault is in one channel only, reverse the outputs from your amplifier to the speakers (right-to-left and left-to-right). If the distortion moves to the other channel, the fault is not in the speaker. (This technique may also be used to locate a fault between the signal source and preamp/receiver and/or between preamp and power amp(s).

If you have been unsuccessful in locating the specific source of trouble (or if you have located it, but have been unable to correct it), make inquiries in the following order:

- ◆ Consult the Authorized Infinity Dealer from whom you purchased the system. Infinity Dealers are audio specialists and can be of great assistance.
- ◆ Get the name and address of the Authorized Infinity Service Facility nearest you by writing

or calling Infinity at (818) 407-0228. **Please ask for Customer Service.** You may be instructed to take or send the problem part to a service facility for service under the terms of the warranty.

NOTE: DO NOT SHIP ANY PARTS OR WHOLE SPEAKERS FOR SERVICE WITHOUT PRIOR APPROVAL ("RETURN AUTHORIZATION"), AND DO NOT SHIP WITHOUT ENCLOSING A COPY OF YOUR ORIGINAL BILL OF SALE.

If there is no authorized service facility near you, or in the unlikely event that the service facility cannot solve the problem:

- ◆ Write, phone, or FAX:
Infinity Systems, Inc.
CUSTOMER SERVICE
20630 Nordhoff Street
Chatsworth, California 91311
(818) 407-0228 • FAX (818) 709-7496

Describe the difficulty as specifically as possible. The Service Department will then advise you as to the action you should take.

KAPPA 5.1 – SPECIFICATIONS

Recommended Amplification	30-150 watts/channel
Frequency Response.....	50Hz-35KHz ± 3dB
Crossover Frequency	350Hz, 3000Hz
Sensitivity	90dB 2.8v / 1 meter
Impedance.....	Compatible with 8 Ohm outputs
Driver Complement.....	EMIT-R Tweeter, 4" IMG™ Midrange, 8" IMG™ Woofer
Cabinet Finish.....	Black Ash
Dimensions	10 ¹ / ₂ " wide, 21 ⁵ / ₈ " high, 12 ³ / ₄ " deep

LIMITED WARRANTY

Who is protected by the warranty?

Your Infinity warranty protects the original retail purchaser and all subsequent owners for a period of five (5) years (parts and labor) from any failure as a result of original manufacturing defect so long as: (1) your Infinity loudspeaker was purchased within the fifty United States or by military personnel from an authorized military outlet and (2) the original dated bill of sale is presented whenever service is required during the warranty period. This warranty does not apply to products purchased elsewhere; other purchasers should contact their local Infinity distributor for warranty information.

What does the Infinity warranty cover?

Except as specified below, this warranty covers all defects in original materials and workmanship. The following are not covered: damage caused by accident, misuse, abuse, neglect, product modification; damage occurring during shipment; damage caused by failure to follow instructions in the owner's manual, including failure to perform recommended periodic or routine maintenance; damage resulting from repairs by someone not authorized by Infinity; claims based upon any misrepresentations by the seller; and any Infinity product on which the serial number has been altered, defaced, or removed.

Who pays for what?

During the period of the warranty, subject to the above conditions, Infinity will pay all of the labor and material expenses to repair a warrantable defect.

How can warranty service be obtained?

In the event that your Infinity loudspeaker should require service, you should first contact the Infinity dealer from whom the product was purchased or, if this is not practical, contact Infinity directly (ATTN: Customer Service) at 20630 Nordhoff Street, Chatsworth, CA 91311, (818) 407-0228. We may direct you to an

authorized service center for Infinity products or ask you to send them to us for repair. In either case, you will have to present your original bill-of-sale to establish warranty coverage. Do not send your speaker to us without prior authorization from our Customer Service Department.

You are responsible for transporting your product to either Infinity or an authorized service center and for payment of all shipping charges; however, Infinity will pay the return shipping charges (in the event you return the product to us) if the repairs are covered by warranty. If you experience difficulty in transporting your product or are in need of packing materials, please advise us and we may be able to suggest alternative procedures and/or provide adequate packing materials.

Limitation of Implied Warranties

All implied warranties, including fitness for a particular purpose and merchantability are limited in duration and length to the warranty period for your product.

Limitation of Incidental or Consequential Damages:

Infinity is not responsible for any incidental or consequential damage of any kind. Our liability is limited to the repair or replacement, at our option, of a defective product.

Some states do not allow limitations on how an implied warranty lasts and/or do not allow the exclusion of incidental or consequential damage, so the above limitations or exclusions may not apply to you.

This warranty gives you specific legal rights and you may also have other rights which vary from state to state.

NOTE: In the event that there is a difference between this warranty and the provisions in any advertisements, product brochures or packaging cartons, the terms of this warranty will prevail.